

**186FA G4**

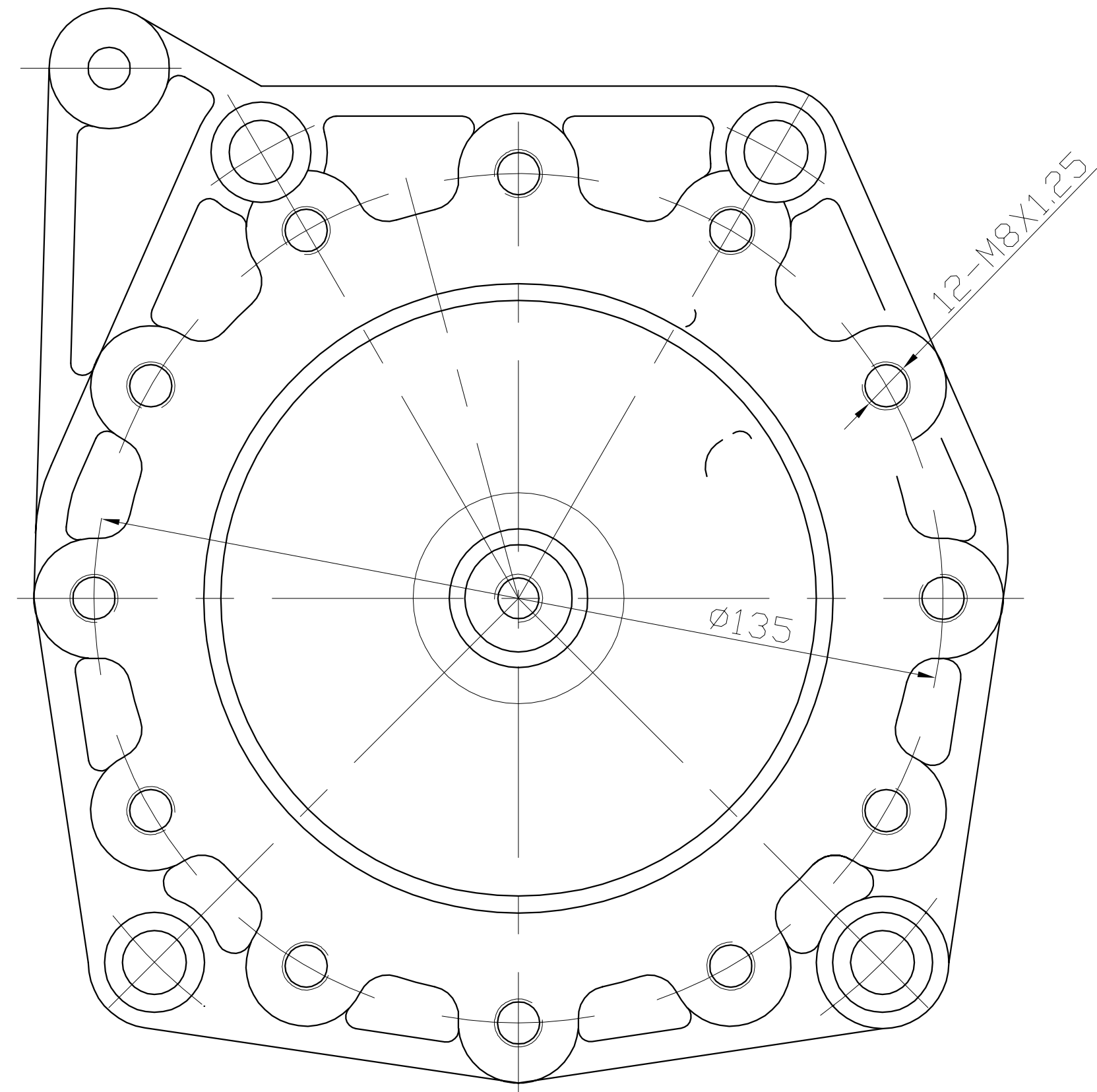

**PTO Flange**